

# ACCESSOIRES POUR DES GROUPEES CENTRIFUGES

---

- Distributeurs
- Bouches pour système pneumatique
- Canons et rotules pour système pneumatique
- Autres accessoires pour système pneumatique
- Rotules et t pour système pneumatique et mixte
- Bouches pour système mixte

**solteka**  
air technical solutions

+34 973 247 973

info@solteka.eu · www.solteka.eu

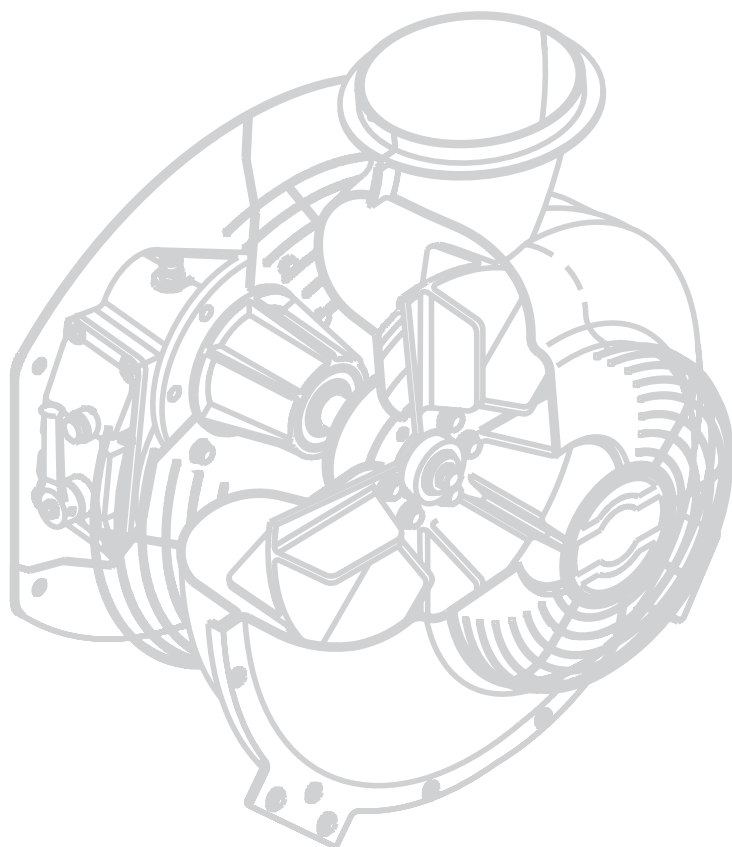

# DISTRIBUTEURS ET AUTRES ACCESSOIRES

		Description	Référence
		<b>DISTRIBUTEUR À 8 SORTIES 100Ø POUR Ø470</b>	111.510.300.00
		<b>DISTRIBUTEUR À 6 SORTIES 100Ø POUR Ø400</b>	111.510.100.00
		<b>DISTRIBUTEUR À 6 SORTIES 100Ø POUR Ø470</b>	111.510.200.00
		<b>DISTRIBUTEUR À 10 SORTIES 100Ø POUR Ø500</b>	111.510.400.00
		<b>DISTRIBUTEUR Á 4 SORTIES 160Ø POUR Ø500</b>	111.526.007.00
		<b>DISTRIBUTEUR À 2 SORTIES 200Ø POUR Ø470</b>	111.520.040.00
		<b>DISTRIBUTEUR HORIZONTAL À 6 SORTIES 100Ø POUR Ø400</b>	111.510.050.00
		<b>DISTRIBUTEUR HORIZONTAL À 6 SORTIES 100Ø POUR Ø470</b>	111.510.060.00

# DISTRIBUTEURS ET AUTRES ACCESSOIRES

Description

Référence

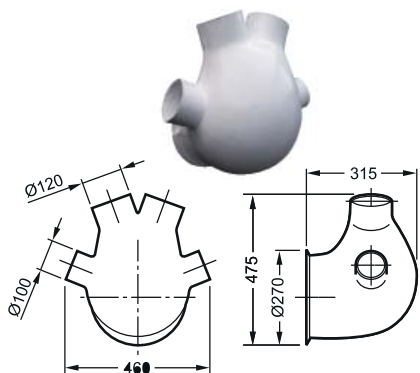

**DISTRIBUTEUR HORIZONTAL Ø275 À 4 SORTIES  
(2 Ø120 + 2Ø100) POUR Ø400**

111.510.040.00

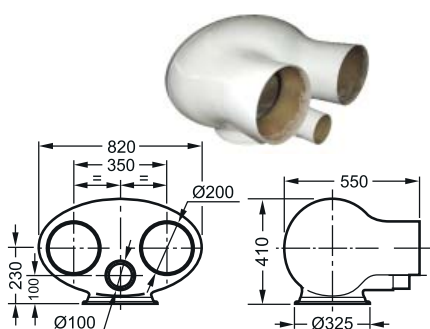

**DISTRIBUTEUR Ø320 À 3 SORTIES HORIZONTALES  
(2 Ø200 + 1Ø100) POUR Ø500**

111.526.001.00

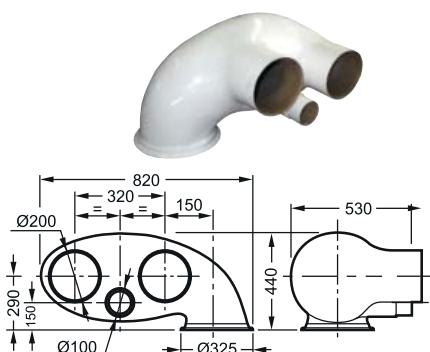

**DISTRIBUTEUR Ø320 À 3 SORTIES HORIZONTALES  
(2 Ø200 + 1Ø100) POUR Ø500**

111.526.002.00

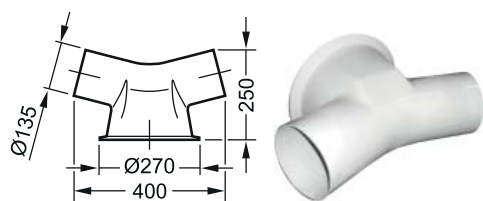

**DISTRIBUTEUR HORIZONTALE À 2 SORTIES Ø135 POUR Ø400**

111.526.003.00

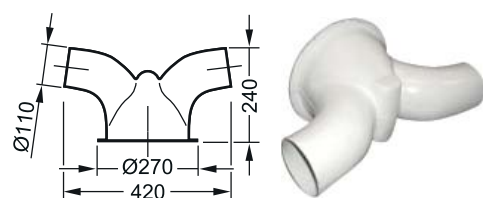

**DISTRIBUTEUR HORIZONTALE À 2 SORTIES Ø110 POUR Ø400**

111.526.004.00

# DISTRIBUTEURS ET AUTRES ACCESSOIRES

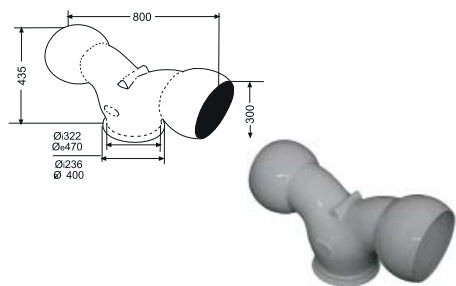

**DISTRIBUTEUR À 2 SORTIES R300 POUR Ø400**

**Référence**

111.526.009.00

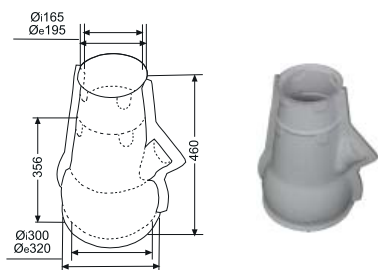

**CANON AVEC ROTULE R300 POUR Ø400**

111.520.020.00

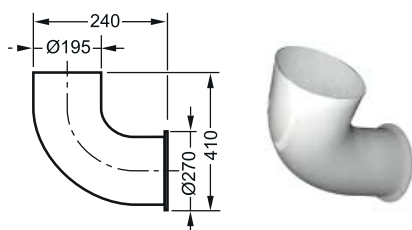

**COUDE Ø270 POUR VOLUTE AVEC TURBINE Ø400**

111.511.000.00

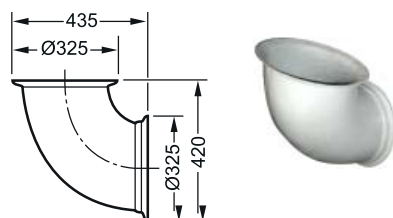

**COUDE Ø325 POUR VOLUTE AVEC TURBINE Ø500**

111.526.005.00

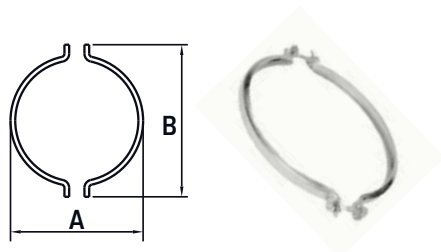

**KIT COLLIERS Ø200**

A  
200

B  
265

111.888.200.00

**KIT COLLIERS Ø265**

265

325

111.888.265.00

**KIT COLLIERS Ø325**

325

390

111.888.325.00

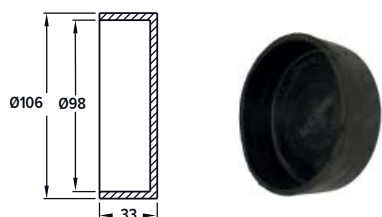

**BOUCHON EN CAOUTCHOUC Ø100**

111.205.000.00

# BOUCHES POUR SYSTÈME PNEUMATIQUE

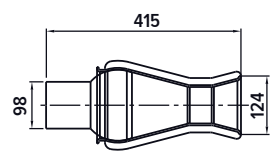

**KIT CANON R150**

111.742.000.09

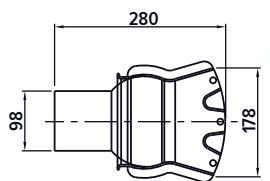

**KIT MAIN À 3 SORTIES R150**

111.744.000.09

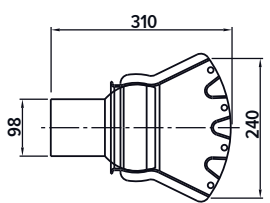

**KIT MAIN À 4 SORTIES R150**

111.745.000.09

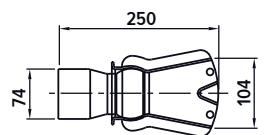

**KIT MAIN À 2 SORTIES R75**

111.743.000.09

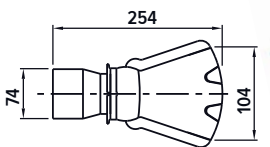

**KIT MAIN À 3 SORTIES R75**

111.747.000.09

## CANONS ET ROTULES POUR SYSTÈME PNEUMATIQUE

		Description	Référence
		KIT MAIN À 4 SORTIES AVEC ROTULE Ø150	111.730.160.09
		KIT MAIN À 3 SORTIES AVEC ROTULE Ø150	111.730.150.09
		KIT MAIN À 2 SORTIES ET ROTULE Ø75	111.730.140.09
		KIT MAIN À 3 SORTIES ET ROTULE Ø75	111.730.141.09
		CANON AVEC ROTULE Ø150	111.730.120.09
		ROTULE Ø150	111.730.130.09
		ROTULE Ø75	111.730.030.09

# AUTRES ACCESSOIRES POUR SYSTÈME PNEUMATIQUE

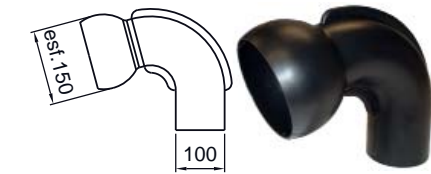

**COUDE AVEC ROTULE Ø150-105°**

111.730.131.09

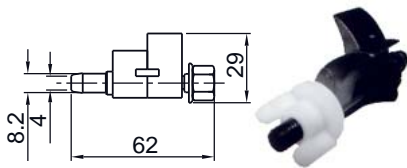

**KIT DIFFUSEUR PNEUMATIQUE**

111.740.000.00



**KIT DIFFUSEUR CANON PNEUMATIQUE**

111.741.000.00

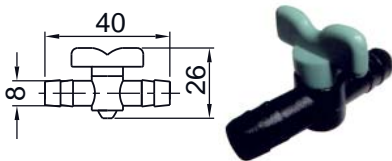

**VANNE CALIBREUSE Ø1,2**

111.200.000.00



**DOUILLE "Y" Ø8 (2 SORTIES)**

611.740.110.00

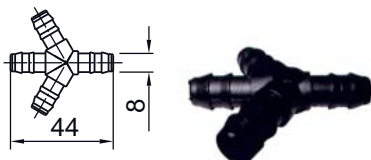

**DOUILLE "Y" Ø8 (3 SORTIES)**



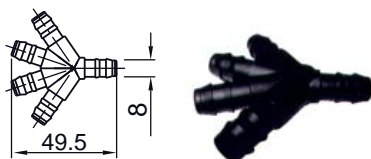







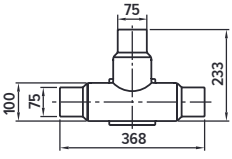

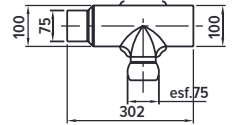

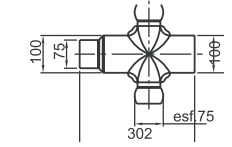

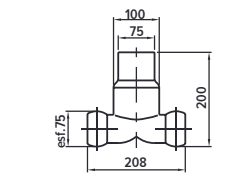
611.740.120.00

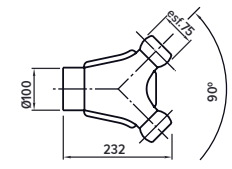

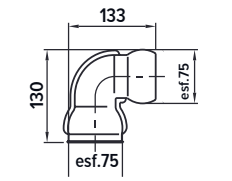
**DOUILLE "Y" Ø8 (4 SORTIES)**

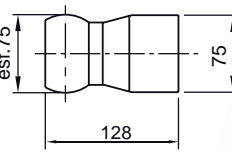
611.740.130.00

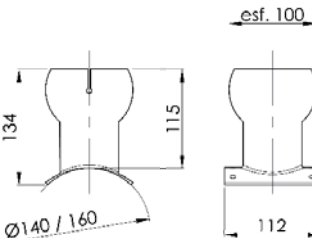
# ROTULES ET T POUR SYSTÈME PNEUMATIQUE ET MIXTE

		Description	Référence
		"T" Ø75/ Ø100	111.730.040.09
		ROTULE INTERMÉDIAIRE Ø75	111.730.031.09
		ROTULE DOUBLE INTERMÉDIAIRE Ø75	111.730.032.09
		"T" AVEC ROTULE Ø75	111.730.010.09
		"Y" AVEC ROTULE Ø75	111.730.033.09
		COUDE AVEC ROTULE Ø75	111.730.070.09
		ROTULE Ø75	111.730.030.09
		ROTULE 100 Ø75 POUR TUYAN Ø140/160	111.730.190.00



## BOUCHES POUR SYSTÈME MIXTE

		Description	Référence
 		<b>DIFFUSEUR EN ABS Ø100</b>	111.735.050.00
 		<b>MAIN VERTICALE R75 (SORTIE 20mm)</b>	111.730.020.09
		<b>MAIN VERTICALE R75 LPT (SORTIE 10mm)</b>	111.730.025.09
 		<b>MAIN HORIZONTALE R75</b>	111.730.060.09
 		<b>MAIN VERTICALE AVEC COUDE R75 (SORTIE 20 mm)</b>	111.730.050.09
		<b>MAIN VERTICALE AVEC COUDE R75 LPT (SORTIE 10 mm)</b>	111.730.055.09
 		<b>MINI MAIN VERTICALE</b>	111.730.080.09

# BOUCHES POUR SYSTÈME MIXTE

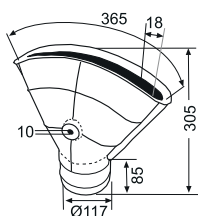
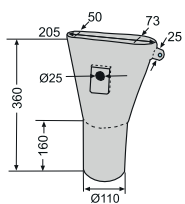
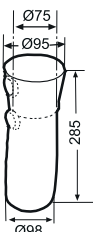
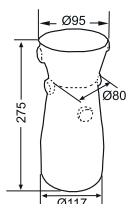
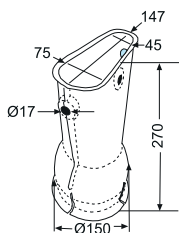
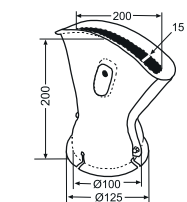

Description

Référence

**MAIN AVEC ROTULE 100Ø KIT 2 COLONNES  
FLUX VERTICAL**

**MAIN POUR ROTULE Ø150 JUSQU'À 3 JETS SUR CANON  
LONGUE PORTÉE ET HAUTEUR Ø300**

**MAIN CYLINDRIQUE Ø120 (A ET B MÉCANISÉS OU  
SANS MÉCANISER)**

111.735.070.00

**MAIN CYLINDRIQUE Ø100 (A ET B MÉCANISÉS  
OU SANS MÉCANISER)**

111.735.060.00

**ENSEMBLE MAIN TRIPLEJET CANON  
LONGUE PORTÉE ET HAUTEUR**

**MAIN Ø120 X 60°**

111.730.090.09

**CANON D200**

111.735.080.00

# BOUCHES POUR SYSTÈME MIXTE

		Description	Référence
		CANON Ø120, 2 PIÈCES, ABS NOIR	
		CANON CULTURES MARAÎCHÈRES Ø120, 2 PIÈCES, ABS NOIR	
		CANON SORTIE PLATE R150 ABS NOIR	
		DEFLECTEUR TYPE PALE	
		MAIN KIT 2 SORTIES BASSES	
		MAIN AVEC ROTULE Ø75 2 JETS	